

JIM-BUOY®

The Best Custom Boat Lines
DenverRope.com
303-809-7274
John@DenverRope.com

DENVER
ROPE

51st

1966-2017

Anniversary

2017 Product Guide

A DIVISION OF
CAL-JUNE

SOLAS and MED Approved Life Rings

Hard Shell SOLAS and MED Series

Features Include:

- Manufactured to U.S.C.G., SOLAS and MED standards
- Rock-Hard polyethylene shell for added durability
- Molded-In Rope Holes for easy rope replacement. 3/8" Polypropylene UV resistant rope
- Retroreflective Tape included



HARD SHELL SOLAS SERIES LIFE RING SPECIFICATIONS

MODEL NUMBER	OUTSIDE DIAMETER	COLOR	PACK PER CASE	WEIGHT PER CASE	USCG APPROVAL NO.	SOLAS APPROVAL NO.	MED APPROVED
SW HSO-30	30"	ORANGE	6	46 lbs.	160.050/155/0	160.150/11/0	Yes
SW HSOH-30*	30"	ORANGE	6	60 lbs.	160.050/175/0	160.150/19/0	Yes
HSO-30	30"	ORANGE	6	46 lbs.	160.050/155/0	160.150/11/0	
HSOH-30*	30"	ORANGE	6	60 lbs.	160.050/175/0	160.150/19/0	

*4kg. for use with quick release devices with self-activated lights and smoke signals

JB SOLAS Series

Features Include:

- Manufactured to U.S.C.G. and SOLAS standards
- Nylon reinforced vinyl cover with rigid urethane foam construction
- Molded-In Rope Holes for easy rope replacement. 3/8" Polypropylene UV resistant rope
- Retroreflective Tape included

JB SOLAS SERIES LIFE RING SPECIFICATIONS

MODEL NUMBER	OUTSIDE DIAMETER	COLOR	PACK PER CASE	WEIGHT PER CASE	USCG APPROVAL NO.	SOLAS APPROVAL NO.
JBSO-30	30"	ORANGE	6	36 lbs.	160.050/135/0	160.150/6/0
JBSOH-30*	30"	ORANGE	6	57 lbs.	160.050/136/0	160.150/7/0

*4kg. for use with quick release devices with self-activated lights and smoke signals



U.S.C.G. Approved Life Rings

Hard Shell Series

Features Include:

- Manufactured to U.S.C.G. standards.
- Rock-Hard polyethylene shell for added durability
- Molded-In Rope Holes for easy rope replacement. 3/8" Polypropylene UV resistant rope
- Retroreflective Tape available, when ordering add "T" to model number

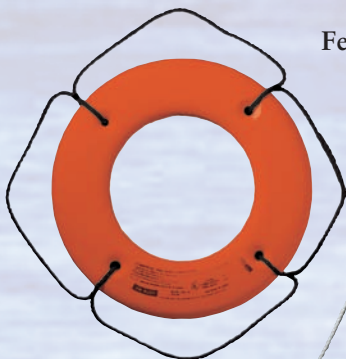

HARD SHELL LIFE RING SPECIFICATIONS

MODEL NUMBER	OUTSIDE DIAMETER	COLOR	PACK PER CASE	WEIGHT PER CASE	USCG APPROVAL NO.
HS-20 W	20"	WHITE	6	26 lbs.	160.050/171/0
HS-20 O	20"	ORANGE	6	26 lbs.	160.050/170/0
HS-24 W	24"	WHITE	6	29 lbs.	160.050/173/0
HS-24 O	24"	ORANGE	6	29 lbs.	160.050/172/0
HS-30 W	30"	WHITE	6	46 lbs.	160.050/174/0
HS-30 O	30"	ORANGE	6	46 lbs.	160.050/154/0

Letter Your Own (Lettering Kit)

Features Include:

- 4 Sets each letters & numbers
- All letters & numbers 2"
- Easy to peel & apply
- Resists Fuel, scratching and fading
- U.V. coated

LETTERING KIT SPECIFICATIONS

MODEL NUMBER	LETTER & NUMBER SIZE	COLOR	PACK PER CASE	WEIGHT PER CASE
91	2"	BLACK	12	6 lbs.



U.S.C.G. Approved Life Rings (cont.)

G and GX Series

G STYLE (WITH WEBBING STRAPS) SPECIFICATIONS



MODEL NUMBER	OUTSIDE DIAMETER	COLOR	PACK PER CASE	WEIGHT PER CASE	USCG APPROVAL NO.
G-19*	19"	WHITE	6	14 lbs.	160.064/185/0
GW-20	20"	WHITE	6	18 lbs.	160.050/48/2
GO-20	20"	ORANGE	6	18 lbs.	160.050/105/1
GW-24	24"	WHITE	6	21 lbs.	160.050/50/2
GO-24	24"	ORANGE	6	21 lbs.	160.050/106/1
GW-30	30"	WHITE	6	33 lbs.	160.050/107/1
GO-30	30"	ORANGE	6	33 lbs.	160.050/107/1



* For recreational use, white only

Features Include:

- Solid closed cell foam throughout
- Soft and resilient to the touch
- Resists rot and mildew
- Double UV inhibitor, to prevent deterioration
- Resists weather and temperature extremes
- Retroreflective Tape available, when ordering add "T" to model number

"GX" STYLE (WITH ROPE MOLDED INTO CORE) SPECIFICATIONS

MODEL NUMBER	OUTSIDE DIAMETER	COLOR	PACK PER CASE	WEIGHT PER CASE	USCG APPROVAL NO.
GW-X-20	20"	WHITE	6	18 lbs.	160.050/61/2
GO-X-20	20"	ORANGE	6	18 lbs.	160.050/102/1
GW-X-24	24"	WHITE	6	21 lbs.	160.050/60/2
GO-X-24	24"	ORANGE	6	21 lbs.	160.050/103/1
GW-X-30	30"	WHITE	6	33 lbs.	160.050/104/1
GO-X-30	30"	ORANGE	6	33 lbs.	160.050/104/1

JB and JBX Series

JB STYLE (WITH WEBBING STRAPS) SPECIFICATIONS



MODEL NUMBER	OUTSIDE DIAMETER	COLOR	PACK PER CASE	WEIGHT PER CASE	USCG APPROVAL NO.
JB-19*	19"	WHITE	6	14 lbs.	160.064/3192/0
JBW-20	20"	WHITE	6	18 lbs.	160.050/145/0
JBO-20	20"	ORANGE	6	18 lbs.	160.050/142/0
JBW-24	24"	WHITE	6	21 lbs.	160.050/147/0
JBO-24	24"	ORANGE	6	21 lbs.	160.050/140/0
JBW-30	30"	WHITE	6	33 lbs.	160.050/149/0
JBO-30	30"	ORANGE	6	33 lbs.	160.050/138/0

* For recreational use, white only

Features Include:

- Nylon reinforced vinyl cover with rigid urethane foam construction
- Resists rot and mildew
- Resists weather and temperature extremes
- Retroreflective Tape available, when ordering add "T" to model number

JBX STYLE (WITHOUT WEBBING STRAPS) SPECIFICATIONS

MODEL NUMBER	OUTSIDE DIAMETER	COLOR	PACK PER CASE	WEIGHT PER CASE	USCG APPROVAL NO.
JBW-X-20	20"	WHITE	6	18 lbs.	160.050/146/0
JBO-X-20	20"	ORANGE	6	18 lbs.	160.050/143/0
JBW-X-24	24"	WHITE	6	21 lbs.	160.050/148/0
JBO-X-24	24"	ORANGE	6	21 lbs.	160.050/141/0
JBW-X-30	30"	WHITE	6	33 lbs.	160.050/150/0
JBO-X-30	30"	ORANGE	6	33 lbs.	160.050/139/0



CANADIAN Approved Lifebuoys

Hard Shell SOLAS Series

Features Include:

- Manufactured to Transport Canada and SOLAS Standards
- Rock-Hard polyethylene shell for added durability
- Molded-In rope holes for easy rope replacement
- 3/8" (9.5mm) Polypropylene UV resistant rope
- Retroreflective tape included



SOLAS

CANADIAN HARD SHELL LIFEBOUY SPECIFICATIONS

MODEL NUMBER	DESCRIPTION	OUTSIDE DIAMETER	COLOR	PACK PER CASE	WEIGHT PER CASE
C-HSO-30	2.5 kg	30" (762 mm)	ORANGE	6	46 lbs. (21kg.)
C-HSOH-30*	4 kg	30" (762 mm)	ORANGE	6	60 lbs. (27kg.)

* 4kg. for use with quick release devices with self-activated lights and smoke signals

Hard Shell Small Vessel Series

CANADIAN HARD SHELL LIFEBOUY SPECIFICATIONS

MODEL NUMBER	OUTSIDE DIAMETER	COLOR	PACK PER CASE	WEIGHT PER CASE
C-HS-24 O	24" (610 mm)	ORANGE	6	29 lbs. (13kg.)
C-HS-24 W	24" (610 mm)	WHITE	6	29 lbs. (13kg.)
C-HS-24 Y	24" (610 mm)	YELLOW	6	29 lbs. (13kg.)



Features Include:

- Manufactured to Transport Canada Standards
- Rock-Hard polyethylene shell for added durability
- Molded-In rope holes for easy rope replacement
- 3/8" (9.5mm) Polypropylene UV resistant rope

Life Ring Cabinets/Safety Stations

Life Ring Cabinets

Features Include:

- Sturdy polyethylene case and backing
- Now available in White, Orange and Yellow cases
- Polycarbonate Non-Breakable window
- Stainless and aluminum hardware



Life Ring Safety Station

Features Include:

- Same as life ring cabinets
- Does include life ring

LIFE RING CABINET/SAFETY STATION SPECIFICATIONS

MODEL NUMBER	DESCRIPTION	BUOY DIAMETER	PACK PER CASE	WEIGHT PER CASE
5030	CABINET	20"	1	13 lbs.
5030 A	SAFETY STATION	20"	1	16 lbs.
5050	CABINET	24"	1	15 lbs.
5050 A	SAFETY STATION	24"	1	20 lbs.
5070	CABINET	30"	1	23 lbs.
5070 A	SAFETY STATION	30"	1	30 lbs.

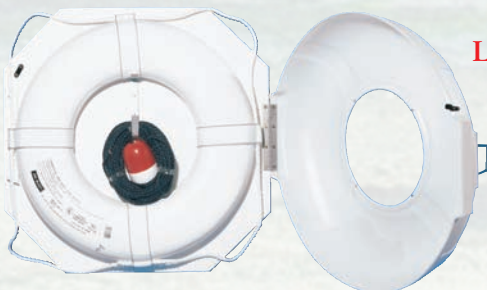

Swimming Pool and Decorative Life Rings

P-Series

Features Include:

- Marine Enamel Coated Polystyrene
- Water-proof
- Non-absorbent closed cell
- Non-slip webbing straps
- Polypropylene grab lines



P-SERIES LIFE RING SPECIFICATIONS

MODEL NUMBER	OUTSIDE DIAMETER	COLOR	PACK PER CASE	WEIGHT PER CASE
P-17	17"	WHITE	6	5 lbs.
P-20	20"	WHITE	6	6 lbs.
P-21	21"	WHITE	6	8 lbs.
P-25	25"	WHITE	6	10 lbs.
P-30	30"	WHITE	6	16 lbs.



Add the following number for COLOR choice when ordering P-Series Buoys:
 #352 - White body with blue bands #241 - White body with white bands.
 All models packed 6 per carton.

C-Series, Canvas Covered

C-SERIES LIFE RING SPECIFICATIONS

MODEL NUMBER	OUTSIDE DIAMETER	COLOR	PACK PER CASE	WEIGHT PER CASE
C-17	17"	NATURAL	6	7 lbs.
C-20	20"	NATURAL	6	8 lbs.
C-21	21"	NATURAL	6	10 lbs.
C-25	25"	NATURAL	6	13 lbs.
C-30	30"	NATURAL	6	20 lbs.

Features Include:

- Canvas Covered
- Non-absorbent closed cell core
- Old nautical style
- Smoothly tailored, heavy duty canvas machine stitched inside and out



ST-Series

ST-SERIES LIFE RING SPECIFICATIONS

MODEL NUMBER	OUTSIDE DIAMETER	COLOR	PACK PER CASE	WEIGHT PER CASE
ST-17	17"	WHITE	6	7 lbs.
ST-20	20"	WHITE	6	8 lbs.
ST-21	21"	WHITE	6	10 lbs.
ST-25	25"	WHITE	6	13 lbs.
ST-30	30"	WHITE	6	20 lbs.



IDEAL FOR PROMOTIONAL PROGRAMS!

Features Include:

- Soft and resilient
- Wide range of colored webbing available
- Limited custom buoy body colors available
- Custom labeling available

Life Ring Racks

The Roughneck Series

JIM-BUOY®



THE ROUGHNECK SERIES SPECIFICATIONS

MODEL NUMBER	BUOY DIAMETER	PACK PER CASE	WEIGHT PER CASE
1123-20	20"	1	4 lbs.
1123-24	24"	2	10 lbs.
1123-30	30"	2	14 lbs.

Features Include:

- Heavy duty welded stainless steel
- Maintenance free
- See below for stanchion line installation u-bolts
- Pre-drilled holes for stanchion and life line mount as well as on cabin wall

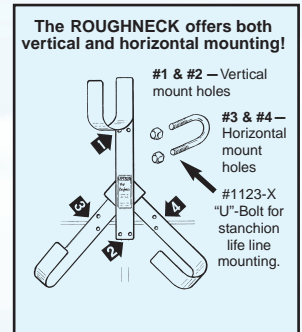

Stainless Steel U-Bolts For Stanchion Line Mounting

4 Stainless steel U-Bolts and nuts for stanchion line assembly per pack
For use with Roughneck series life ring racks

STAINLESS STEEL U-BOLT SPECIFICATIONS

MODEL NUMBER	PACK PER CASE	WEIGHT PER CASE
1123-X	10	2 lbs.

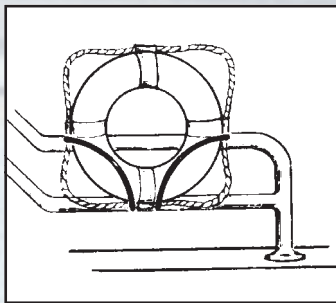
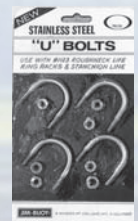

Wall or Rail Mount #804

Features Include:

- Stainless steel construction
- Readily mounts to safety rail, stanchion or cabin wall

Ring Buoy Hangers



Model #1122

RING BUOY HANGER SPECIFICATIONS

MODEL NUMBER	PACK PER CASE	WEIGHT PER CASE
804	12	8 lbs.
1122	6	8 lbs.

Marine Life Ring Mount

MARINE LIFE RING MOUNT SPECIFICATIONS

MODEL NUMBER	PACK PER CASE	WEIGHT PER CASE
803	12	4 lbs.

Features Include:

- EASILY accessible
- Fits all life ring sizes
- 2 Anodized aluminum brackets
- Economical

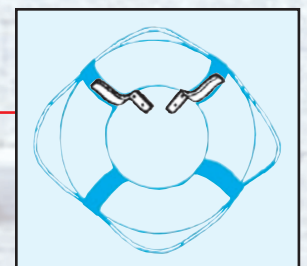

Display Packaged #803

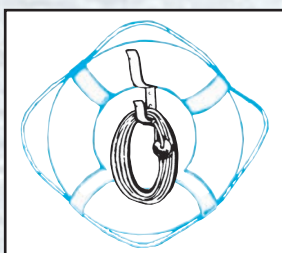

Model# 800-30,60

Features Include:

- Anodized aluminum, fits all sizes
- Includes 30' or 60' Yellow UV resistant polypropylene throw line with foot anchor
- Other rope lengths available on request

BRACKET WITH THROW LINE SPECIFICATIONS

MODEL NUMBER	THROW ROPE LENGTH	PACK PER CASE	WEIGHT PER CASE
800-30	30'	6	7 lbs.
800-60	60'	6	7 lbs.



Model# 800-30,60
Display Packaged

Life Preservers

Type I U.S.C.G. Life Preservers



JIM-BUOY®

TYPE I U.S.C.G. LIFE PRESERVER SPECIFICATIONS

MODEL NUMBER	DIMENSIONS	COLOR	PACK PER CASE	WEIGHT PER CASE	U.S.C.G. APPROVAL NO.
601	Adult 24"x12"x3"	ORANGE	6	9 lbs.	160.055/115/0
603	Child 17½"x10"x2½"	ORANGE	6	7 lbs.	160.055/116/0



Features Include:

- 100% closed cell construction
- Stainless steel hardware
- Slide through belt ready at all times
- Completely reversible
- To order retroreflective tape add "T"

Type IV U.S.C.G. Buoyant Boat Cushion

Features Include:

- Soft unicellular construction
- Vinyl coating resists most chemicals and fuels
- Mildew Resistant
- Available in white / orange / blue



TYPE IV U.S.C.G. BUOYANT BOAT CUSHION SPECIFICATIONS

MODEL NUMBER	DIMENSIONS	COLOR	PACK PER CASE	WEIGHT PER CASE	U.S.C.G. APPROVAL NO.
101-W	15½"x15½"x2½"	WHITE	6	14 lbs.	160.064/1228/1
101-O	15½"x15½"x2½"	ORANGE	6	14 lbs.	160.064/1228/1
101-B	15½"x15½"x2½"	BLUE	6	14 lbs.	160.064/1228/1

S.O.S. Flag

S.O.S. Flag

Features Include:

- Heavy Plastic with resealable storage bag with "SOS" label for quick identification
- Complies with U.S.C.G. requirements



JIM-BUOY®

S.O.S. FLAG SPECIFICATIONS

MODEL NUMBER	PACK PER CASE	WEIGHT PER CASE
1851	6	2 lbs.



Automatic Safety Light

Man Overboard Light & Rack



Features Include:

Meets SOLAS 74/83 requirements

When the light is thrown overboard the light automatically commences to flash

Requires 4 alkaline D cell batteries - batteries not included

Also available Model #1821 stainless steel mounting rack



MAN OVERBOARD LIGHT & RACK SPECIFICATIONS

MODEL NUMBER	PACK PER CASE	WEIGHT PER CASE	U.S.C.G. APPROVAL NO.
1820	6	13 lbs.	160.010/12/2
1821	6	6 lbs.	



PFD Light

Features Include:

Most reliable and least expensive

Requires one "D" cell battery, change every three years

Complete with stainless steel clasp

"D" Ring straps available, specify #452



PFD LIGHT SPECIFICATIONS

MODEL NUMBER	PACK PER CASE	WEIGHT PER CASE	U.S.C.G. APPROVAL NO.
450	24	4 lbs.	160.012/70



Day Mark Signals

Features Include:

Heavy-Duty vinyl coated nylon fabric with galvanized framing

Fully collapsible when stored

Black Only

DAY MARK SIGNAL SPECIFICATIONS

MODEL NUMBER	DESCRIPTION	PACK PER CASE	WEIGHT PER CASE
1900	Ball Shape, 24" Dia.	6	10 lbs.
1901	Cone Shape, 24"x 24"	6	9 lbs.
1902	Double Cone Shape, 24"x 48"	6	10 lbs.
1903	Cylinder Shape, 24"x 48"	6	10 lbs.

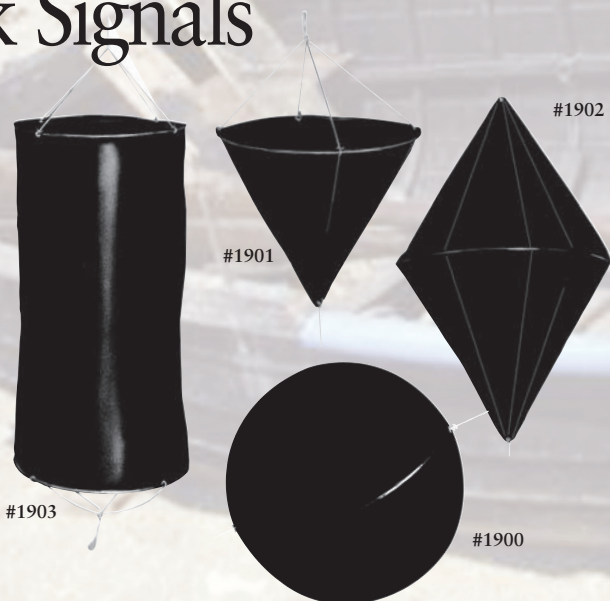

Life Floats & Buoyant Apparatus

Life Floats & Buoyant Apparatus

JIM-BUOY®

Features Include:

- Tough resilient vinyl surface
- Lightweight yet easily exceeds the most severe U.S.C.G. test
- No exposed metal hardware-all double webbing beackets secured inside the float body
- Solid closed-cell plastic throughout
- Retroreflective tape included
- GRS-glass reinforced surface has a fiberglass skin which produces a tougher yet slightly resilient surface
- Model 500 Repair Kit available for small repairs - 6 per carton

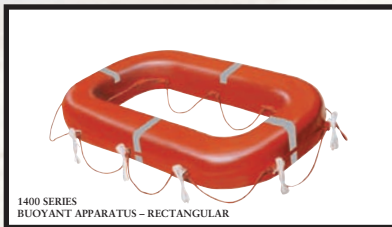
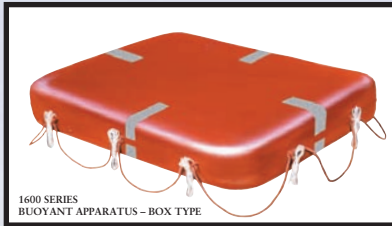

U.S.C.G. LIFE FLOATS & BUOYANT APPARATUS SPECIFICATIONS

	MODEL STANDARD	MODEL GRS	PERSON CAPACITY	APP. LENGTH	APP. WIDTH	SEC. DIAMETER	SHIP WEIGHT	U.S.C.G. APPROVAL NO.
LIFE FLOATS	1206	1206-GRS	6	50-½"	36-½"	8-½"	23 lbs.	160.027/79/2
	1208	1208-GRS	8	51"	37"	9"	25 lbs.	160.027/75/2
	1210	1210-GRS	10	63"	37"	9"	30 lbs.	160.027/76/2
	1212	1212-GRS	12	78"	37"	9"	38 lbs.	160.027/80/2
	1215	1215-GRS	15	64"	48"	12-½"	58 lbs.	160.027/77/2
	1222	1222-GRS	22	100"	48"	12-½"	88 lbs.	160.027/78/2
BUOYANT APPARATUS BOX TYPE	1612	1612-GRS	12	48"	48"	9"	35 lbs.	160.010/70/2
	1618	1618-GRS	18	62"	48"	9"	45 lbs.	160.010/71/2
	1620	1620-GRS	20	84"	48"	9"	55 lbs.	160.010/72/2
BUOYANT APPARATUS RECTANGULAR	1410	1410-GRS	10	51"	37"	9"	23 lbs.	160.010/73/2
	1412	1412-GRS	12	63"	37"	9"	28 lbs.	160.010/74/2
	1418	1418-GRS	18	64"	48"	12-½"	56 lbs.	160.010/75/2
	1422	1422-GRS	22	100"	48"	12-½"	86 lbs.	160.010/76/2
BUOYANT APPARATUS RECTANGULAR WITH NET PLATFORM	1308	1308-GRS	8	51"	37"	9"	23 lbs.	160.010/77/2
	1310	1310-GRS	10	63"	37"	9"	28 lbs.	160.010/78/2
	1315	1315-GRS	15	64"	48"	12-½"	56 lbs.	160.010/79/2
	1322	1322-GRS	22	100"	48"	12-½"	86 lbs.	160.010/80/2

Float-Free Link, Painter Cage

Model 501, Available in 6-10 man, 11-20 man and 21 or more link size. 100ft. 5/16" polypropylene (1600 lb. test) and wire link

Model 504, Fits any stack of four rafts or any stack which equals 21 persons. 7/16" polypropylene (3000 lb. test) and wire link

FLOAT-FREE LINK, PAINTER CAGE SPECIFICATIONS

MODEL NUMBER	PACK PER CASE	WEIGHT PER CASE
501*	12	38 lbs.
504	6	38 lbs.

* INDICATE LINK SIZE

JIM-BUOY®

COMPLIES WITH U.S.C.G. REQUIREMENTS

Contact your local U.S.C.G. office for complete information.



Horseshoe Buoys

Premium Horseshoe With Built-In Sea Anchor



Standard Horseshoe Buoy



PREMIUM HORSESHOE BUOY SPECIFICATIONS

MODEL NUMBER	COLOR	PACK PER CASE	WEIGHT PER CASE	U.S.C.G. APPROVAL NO.
1020	WHITE	6	18 lbs.	160.064/076/0
1040	WHITE	6	17 lbs.	160.064/228/0

Features Include:

- Strong vinyl coated nylon cover
- Heavy duty zipper
- Stainless steel hardware
- Resistant to rot and mildew

STANDARD HORSESHOE BUOY SPECIFICATIONS

MODEL NUMBER	COLOR	PACK PER CASE	WEIGHT PER CASE	U.S.C.G. APPROVAL NO.
920	YELLOW	6	18 lbs.	160.064/076/0
940	YELLOW	6	17 lbs.	160.064/228/0

Horseshoe Buoy Racks

Features Include:

- 1/4" welded stainless steel construction
- Designed to keep buoy in place yet ready in an instant

HORSESHOE BUOY RACK SPECIFICATIONS

MODEL NUMBER	PACK PER CASE	WEIGHT PER CASE
921 Horseshoe	6	11 lbs.
941 Pony	6	10 lbs.
1121 Pony and Horseshoe	6	8 lbs.

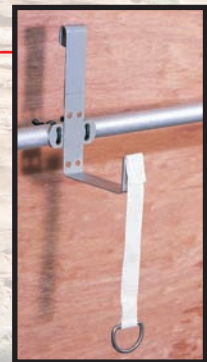

Model #1121

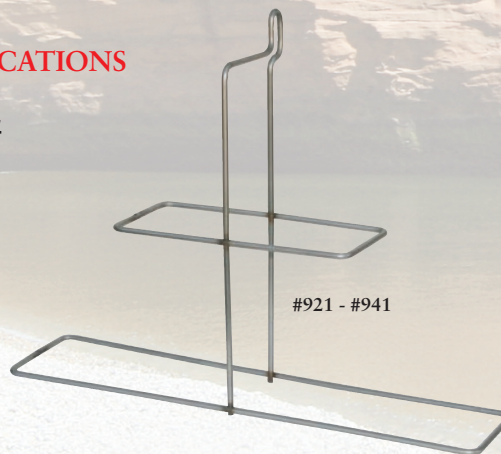

Rectangular horseshoe rack



JIM-BUOY®



Letter Your Own (Lettering Kit)

Features Include:

- 4 Sets each letters & numbers
- All letters & numbers 2"
- Easy to peel & apply
- Resists fuel, scratching and fading
- U.V. coated

LETTERING KIT SPECIFICATIONS

MODEL NUMBER	LETTER & NUMBER SIZE	COLOR	PACK PER CASE	WEIGHT PER CASE
91	2"	BLACK	12	6 lbs.

Man Overboard Poles / Mounts

The Straddler

Features Include:

- High-density polyethylene
- Straddler float with retroreflective bands
- Tough fiberglass pole, nylon flag
- Secure mounting and fast release with model #1124-X or #1124-Y
- 30' line included

All poles can UPS!

Economy Model

Features Include:

- Vinyl-coated tough PVC pipe construction
- Urethane foam filled
- Retroreflective tape band
- Tough fiberglass pole, nylon flag
- 30' line included

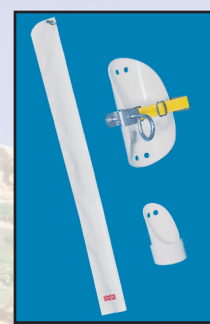

#905

MAN OVERBOARD POLE SPECIFICATIONS

MODEL NUMBER	LENGTH	TYPE	PACK	SHIPPING WEIGHT
924	14'	STRADDLER	1	12 lbs.
924-10	10'	STRADDLER	1	10 lbs.
950	11-1/2'	ECONOMY	1	10 lbs.

MAN OVERBOARD POLE MOUNT SPECIFICATIONS

MODEL NUMBER	MAN OVERBOARD POLE	PACK	SHIPPING WEIGHT
1124-X	STRADDLER 5/32" TO 1/4" DIA. BACKSTAY	6	7 lbs.
1124-Y	STRADDLER 5/16" TO 3/8" DIA. BACKSTAY	6	7 lbs.
905	950	6	16 lbs.

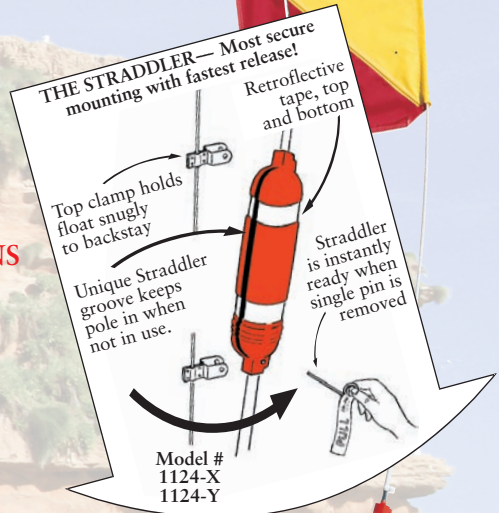

Mast Buoys

MAST BUOY SPECIFICATIONS

MODEL NUMBER	LENGTH	PACK	SHIPPING WEIGHT
1714	4'	2	6 lbs.
1716	6'	2	6 lbs.
1718	8'	2	6 lbs.

Features Include:

- Tough fiberglass pole
- Hard polypropylene shell, foam filled
- Galvanized steel hardware and eye



#1714

#1716

#1718

Trip Line & Anchor Marker Buoy

Wherever anchors are used this buoy is required gear. As the anchor is dropped, the tripline Anchor Buoy with its 100ft. line goes with it. One end of the buoy line is attached to the trip shackle of the anchor; the buoy rises to the surface, unwinding as it rises. At the surface it is tied off in the cleat that is built into the buoy-marking the anchor spot and ready to trip the anchor when needed.

The buoy is manufactured of the toughest resilient foam available, bright orange in color complete with 100 ft. of black weather-resistant line of 800 lbs. breaking strength.



Model #1204, 6 per carton, Shipping wt. 7 lbs.



Model #950
11-1/2' Economy

Model #924
14' Straddler

Model #924-10
10' Straddler



PICK UP BUOYS

Features polypropylene rope through solid foam float, with assorted band colors. Hot-dipped galvanized thimble.

Model #1203, 6 per carton, Shipping wt. 3 lbs.

Regulatory Buoys, Channel

Regulatory Buoys and Channel Markers

All Models

Features Include:

- Shell:** High density polyethylene
- Internal Foam:** 2-3 lb. density polyurethane foamed to waterline (foam filled, upon request)
- Internal Ballast:** Reinforced concrete
- Labels:** stock labels included in buoy price - no extra charge
- Designed to float with 35-40 lbs. of chain or equivalent weight**
- Special labels:** Call for quotation

Accessories

- Reflective Tape:** Various colors (orange, red, green, silver) and widths available upon request
- #9000-X Jim-Buoy lights** available for all models
- Pick-up eye**
- Radar reflectors**
- Model #10 Replacement labels** available
- External ballast**



REGULATORY BUOY AND CHANNEL MARKER SPECIFICATIONS

MODEL	427-R	427 River Buoy	427	427-N	425-R	425	426
Molded-in color	White	White	Green	Red	White	Green	Red
Overall height	45"	45"	45"	45"	59"	59"	59"
Can diameter	10"	10"	10"	10"	12"	12"	12"
Base diameter	21"	21"	21"	19"	13"	13"	13"
Height above waterline (foam line)	40"	40"	40"	40"	41"	41"	41"
Weight	38 lbs.	38 lbs.	38 lbs.	38 lbs.	25 lbs.	25 lbs.	25 lbs.
Galvanized steel eye-bolt	1/2"	1/2"	1/2"	1/2"	5/8"	5/8"	5/8"
Chain required to float upright	Yes	Yes	Yes	Yes	Yes	Yes	Yes

Vinyl Daymarks

JIM-BUOY®

For all Jim Buoy Regulatory Buoys

JIM-BUOY®

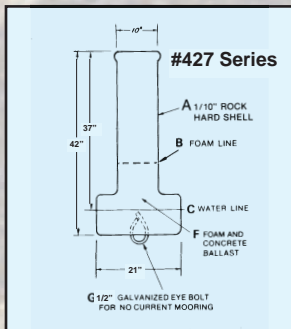

REGULATORY BUOYS, MODELS #410, #410X, #425R, #427R, #428R, #3000					CHANNEL MARKERS	
CONTROLLED AREA SLOW 5 MPH NO WAKE IDLE SPEED SLOW NO WAKE	EXCLUSION AREA KEEP OUT NO BOATS NO SWIMMING SWIM AREA SKI AREA DAM FISHING NO FISHING NO SKIING	DANGER-HAZARD REEF DANGER ROCKS STUMP HAZARD SHOALS DANGER DAM AHEAD	 ROCKS OR UNDERWATER OBSTRUCTION	 RESTRICTED TRAVEL	#425 CAN UPSTREAM GREEN ON LEFT	#426 NUN UPSTREAM RED ON RIGHT
OVER 200 ADDITIONAL SYMBOLS AVAILABLE - NO CHARGE						

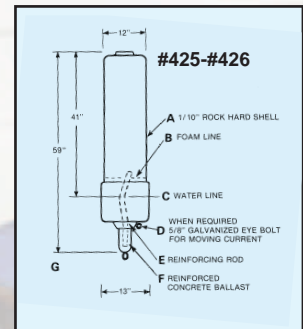

Markers and River Buoys

Regulatory Buoys and Channel Markers

All Models

Features Include:

Shell: High density polyethylene

Internal Foam: 2-3 lb. density polyurethane foamed to waterline (foam filled, upon request)

Internal Ballast: Reinforced concrete

Labels: 200 stock labels included in buoy price - no extra charge

Designed to float with 35-40 lbs. of chain or equivalent weight (models 410, 410-X, fully ballasted)

Special labels: Call for quotation

Accessories

Reflective Tape: Various colors (orange, red, green, silver) and widths available upon request
#9000-X Jim-Buoy lights available for all models

Pick-up eye

Radar reflector

Model #10 Replacement labels available

External ballast for models 3000 and 428-R



JIM-BUOY®

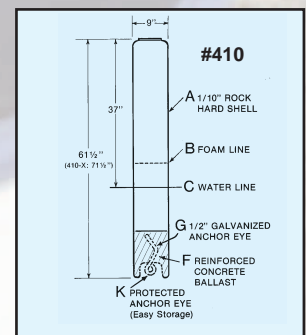

REGULATORY BUOY SPECIFICATIONS

MODEL	410	410-X	428-R	3000
Molded-in color	White	White	White	White
Overall height	61-1/2"	71-1/2"	62-1/2"	37"
Can diameter	9"	9"	15"	12-1/2"
Base diameter	9"	9"	19"	24"
Height above waterline (foam line)	37"	44"	41"	30"
Weight	50 lbs.	58 lbs.	65 lbs.	40 lbs.
Galvanized steel eye-bolt	1/2"	1/2"	5/8"	1/2"
Chain required to float upright	No	No	Yes	Yes

JIM-BUOY®

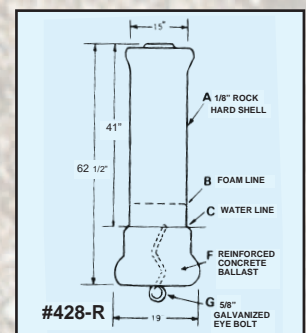

JIM-BUOY®

WARNING!

Always use equal metals at contact point to prevent electrolysis & excess abrasion

Inspect contact points regularly

Sombrero Buoy

Sombrero Buoy

Features Include:

- Shell:** High density polyethylene
- Internal Foam:** 2-3 lb. density polyurethane foamed to waterline (foam filled, upon request)
- Internal Ballast:** Reinforced concrete
- Labels:** standard labels included in buoy price - no extra charge
- Designed to float with 35-40 lbs. of chain or equivalent weight**
- Special labels:** Call for quotation

Accessories

- Reflective Tape:** Various colors (orange, red, green, silver) and widths available upon request
- #9000-X Jim-Buoy lights** available for all models
- Pick-up eye**
- Radar reflectors**
- Model #10 Replacement labels** available
- External ballast**
- 2" Wide aluminum band**

No. 2020-Riser
9" x 60"
Above Water Line 66"

No. 2019-Riser
12" x 24"
Above Water Line 30"

No. 2021-Riser
10" x 39"
Above Water Line 45"

No. 2022-Riser
10" x 39"
Above Water Line 45"

Red Nun No. 2018-Riser
12" x 24"
Above Water Line 30"



SOMBRERO BUOY SPECIFICATIONS

MODEL NUMBER	COLOR	BASE DIAMETER	RISER DIAMETER	HEIGHT ABOVE WATER	WEIGHT	GALVANIZED STEEL EYE
2018	RED	30"	12"	30"	50 lbs.	1/2"
2019	GREEN	30"	12"	30"	56 lbs.	1/2"
2020	WHITE	30"	9"	66"	98 lbs.	1/2"
2021	GREEN	30"	10"	45"	78 lbs.	1/2"
2022	WHITE	30"	10"	45"	78 lbs.	1/2"



No. 2025-Riser
12" x 41"
Above Water Line 47"

No. 2024-Riser
12" x 41"
Above Water Line 47"

Red Nun No. 2026-Riser
12" x 41"
Above Water Line 47"

No. 2028-Riser
15" x 50"
Above Water Line 56"

Red Nun No. 2023-Riser
10" x 39"
Above Water Line 45"



SOMBRERO BUOY SPECIFICATIONS

MODEL NUMBER	COLOR	BASE DIAMETER	RISER DIAMETER	HEIGHT ABOVE WATER	WEIGHT	GALVANIZED STEEL EYE
2023	RED	30"	10"	45"	78 lbs.	1/2"
2024	WHITE	30"	12"	47"	65 lbs.	5/8"
2025	GREEN	30"	12"	47"	65 lbs.	5/8"
2026	RED	30"	12"	47"	65 lbs.	5/8"
2028	WHITE	30"	15"	56"	105 lbs.	5/8"

Buoy Accessories

Mooring Anchors (concrete)

Complete with hot-dipped galvanized eye and available in the following weights:
 Model #4100-45 —45 lbs. Model #4100-180 —180 lbs.
 Model #4100-90 —90 lbs. Model #4100-300 —300 lbs.



JIM-BUOY®
DO-IT-YOURSELF SYSTEM #10 DAYMARKS

Now Available for user application—It's easy to apply and features the same long-lasting, self-adhesive vinyl that is furnished on all Jim Buoy Regulatory Buoys. Order standard wording and symbols or inquire for pricing and delivery on special wording and symbols.

#10 Specify Wording and Symbol

Requires 2 Labels Per Buoy

Do-It-Yourself Daymarks

Marker, Buoy and Utility Lights



Solar Powered Marker and Buoy Light

Features Include:

- 1 Mile visibility
- Solar powered and solar controlled
- 3 mode switch
 - steady on
 - slow flash (15 per min.)
 - fast flash (60 per min.)
- Weather proof
- Shock resistant
- Colors available white, green, red or amber



Display Packaged

MODEL NUMBER	DESCRIPTION	SHIPPING WEIGHT	PER CASE
8900	Marker and Buoy Light	1 lb.	1

Tide Master

ANCHORING SYSTEM for CHANNEL MARKERS and REGULATORY BUOYS

Designed for use where minimum drift anchoring is required—The new Jim Buoy Tide master Anchoring System will help to stabilize and maintain position for all Jim Buoy Channel Markers and Regulatory Buoys with minimum drift to either side during tidal movement and current flow.

How it works: The unique design, (see sketch) incorporates a stainless steel cable (1), that is attached to the buoy anchor (2), and then passes through the stainless steel bracket/ pulley assembly hooked to the base of the buoy (3). The other end of the cable is fastened to a 40 lb. counterweight (4). During actual use, the counterweight shifts up and down in response to tidal movements and current flow and the buoy's position remains relatively unaffected. *Please call for complete details and pricing information.*

Counterweight shifts up and down to maintain buoy position during tidal changes.

Individually boxed, suitable for display.

#9000-1, Stainless steel mounting rack.
 #9000-2, Theft deterrent cable.

Features Include:

- 1 Mile visibility
- 9000-X 40 milliseconds per flash, 30 flashes per minute
- 9000-XSB steady burn-no flash
- All available white, green, amber or red LED
- Uses 3 D-cell batteries, solar controlled
- Available to mount on all channel and regulatory buoys



BUOY LIGHT AND ACCESSORIES SPECIFICATIONS

MODEL NUMBER	DESCRIPTION	SHIPPING WEIGHT	PER CASE
9000-X	HIGH INTENSITY 9000 LIGHT, WHITE, RED, GREEN, AMBER	5 lbs.	6
ACCESSORIES AVAILABLE			
9000-1	STAINLESS STEEL MOUNTING RACK	1lbs.	1
9000-2	THEFT DETERRENT CABLE AND ACCESSORIES	1 lbs.	1
9000-3	FLOAT FOR #9000 LIGHT	1 lbs.	1
9000-4	4 FT. EXTENDED SHAFT, BALLASTED W/FLOAT	5 lbs.	1
9000-6	6 FT. EXTENDED SHAFT, BALLASTED W/FLOAT	6 lbs.	1
9000-12	12 FT. EXTENDED SHAFT, BALLASTED W/FLOAT	12 lbs.	1
9000-FLG	FLANGE ADAPTER FOR REGULATORY BUOY		

Mooring Buoys

Swivel and Eye Style Mooring Buoys



Features Include:

Hot dipped galvanized swivel & eye;
also available in stainless steel

Interior rod bent to prevent pull-thru in stormy conditions

Hard Polyethylene shell - 2lb. high-density foam filled
Standard color white

Also available in orange, specify O and yellow, specify Y

PREMIUM MARK V SELECTION CHART

MODEL NUMBER	DIAMETER	SWIVEL & EYE	BUOYANCY (+ OR -5 lbs.)	PACK	SHIPPING WEIGHT
4400	12"	1/2"	22 lbs.	4	26 lbs.
4401	15"	1/2"	46 lbs.	4	42 lbs.
4402	18"	1/2"	90 lbs.	1	14 lbs.
4403	24"	5/8"	209 lbs.	1	27 lbs.
4404	30"	5/8"	400 lbs.	1	47 lbs.

Tube Style Mooring Buoys

PREMIUM MARK V SELECTION CHART-TUBE STYLE

MODEL NUMBER	DIAMETER	TUBE SIZE	BUOYANCY (+ OR -5 lbs.)	PACK	SHIPPING WEIGHT
4402-T-2"	18"	2"	87 lbs.	1	13 lbs.
4402-T-2 1/2"	18"	2 1/2"	86 lbs.	1	13 lbs.
4402-T-3"	18"	3"	85 lbs.	1	13 lbs.
4403-T-2"	24"	2"	196 lbs.	1	24 lbs.
4403-T-2 1/2"	24"	2 1/2"	195 lbs.	1	24 lbs.
4403-T-3"	24"	3"	194 lbs.	1	24 lbs.
4404-T-2"	30"	2"	396 lbs.	1	47 lbs.
4404-T-2 1/2"	30"	2 1/2"	395 lbs.	1	47 lbs.
4404-T-3"	30"	3"	394 lbs.	1	47 lbs.

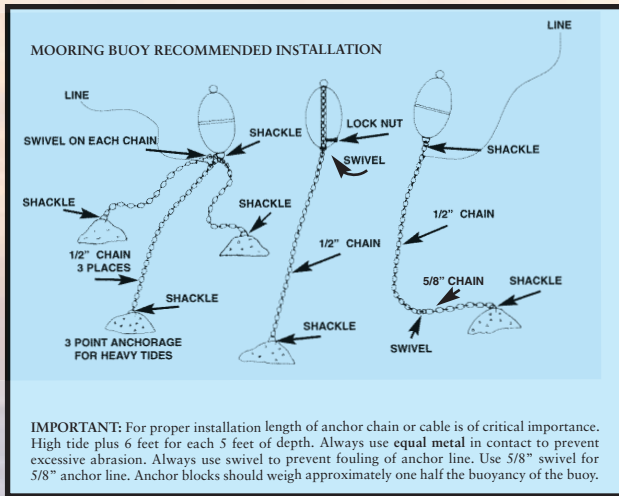

IMPORTANT: For proper installation length of chain or cable is of critical importance. High tide plus 6 feet for each 5 feet of depth. Always use equal metal in contact to prevent excessive abrasion. Always use swivel to prevent fouling of anchor line. Use 5/8" swivel for 5/8" anchor line. Anchor blocks should weigh approximately one half the buoyancy of the buoy.

Features Include:

2", 2 1/2" and 3" PVC tube, other tube sizes available please contact factory

Hard Shell - 2lb. High-density foam filled

Standard color white

Also available in orange, specify O and yellow, specify Y

Also available with extended tubes, specify EXT

JIM-BUOY®

Drum Mooring Buoy



Features Include:

Heavy-duty construction

High density polyethylene

Maximum Stability- flat top and bottom

Galvanized swivel and eye, stainless available on request

3" Tube will accommodate model 4000 mooring system

DRUM BUOY SELECTION CHART

MODEL NUMBER	DIAMETER	SWIVEL & EYE	BUOYANCY (+ OR -5 lbs.)	PACK	SHIPPING WEIGHT
4304	30"	5/8"	240 lbs.	1	33 lbs.
4304-T	30"	3" tube	230 lbs.	1	30 lbs.

Mooring Buoys and Accessories

JIM-BUOY®

“NEW” Pendant Buoy

Features Include:

- Shell: high density polyethylene
- Keeps mooring/pendant line dry
- Protects boat from contact with mooring hardware
- Stable in water - won't roll over causing mooring line to get wet
- Stackable when not in use - with mooring line and hardware when moorings are pulled out during winter months
- Lifting grips to aid in handling
- Blue reflective tape
- Other colors available



PENDANT BUOY SELECTION CHART

MODEL NUMBER	(SPECIFY) TUBE SIZE	BUOYANCY (+ OR - lbs.)	DIMENSIONS	COLOR	PACK PER CARTON	SHIPPING WEIGHT
4202-T	2", 2 1/2", 3"	105 lbs.	18"	WHITE	1	16 lbs.
4203-T	2", 2 1/2", 3"	240 lbs.	24"	WHITE	1	32 lbs.
4204-T	2", 2 1/2", 3"	460 lbs.	30"	WHITE	1	55 lbs.

“NEW” Winter Spar Buoy

Features Include:

- Replaces mooring buoys during winter months
- Heavy duty polyethylene resists wear from ice and harsh conditions
- Tapered to keep free in icy conditions
- Hot-Dipped 5/8" galvanized eye
- Blue reflective tape
- Available in White, Orange and Yellow

Model #511

Model #510



WINTER SPAR BUOY SPECIFICATIONS

MODEL NUMBER	DIMENSIONS DIA. x HEIGHT	HARDWARE	PACK	SHIPPING WEIGHT
510	6" x 36"	5/8" Eye	1	6 lbs.
511	6" x 60"	5/8" Eye	1	17 lbs.

Moor-Pro Buoy Protector

Features Include:

- Protects mooring buoy from shackle wear
- Rounded edges keep pendant line from fraying
- Available for all 2", 2 1/2" and 3" tube size mooring buoys slides easily into place
- Can be permanently installed or allowed to spin to keep anchor/pendant line from twisting



Moor-Pro Reinforcing Tube Collar

MOOR-PRO BUOY PROTECTOR SELECTION CHART

MODEL NUMBER	FOR USE WITH	PACK	SHIPPING WEIGHT
4001	2" TUBE	6	3 lbs.
4002	2 1/2" TUBE	6	3 lbs.
4003	3" TUBE	6	3 lbs.

#1 Mooring System

#4000 Star Plate and Ring Assembly

Features Include:

- Hot dipped galvanized star plate, 6" ring and shackle
- Requires minimum 3" tube
- Ring kept in constant upright position by chain weight tension
- Rugged 1/4"x 6" diameter concave star plate protects top of mooring buoy from wear

STAR PLATE AND RING ASSEMBLY SELECTION CHART

MODEL NUMBER	PACK PER CASE	SHIPPING WEIGHT
4000	1	5 lbs.



Mooring Buoys

Deluxe Series

Features Include:

- High Density polystyrene foam assures lasting durability
- All Hardware is hot-dipped galvanized medium carbon steel
- Eyebolts are molded into buoy to prevent "pull through"
- Rubber bumpers give added protection in contact
- All buoys are coated with an exterior coating that resists extreme weathering, most chemicals and fuels

JIM-BUOY®

DELUXE SERIES SELECTION CHART

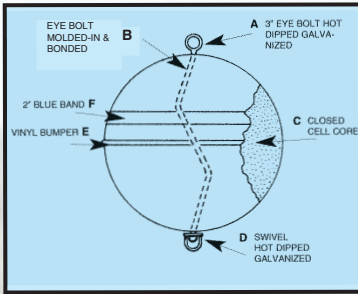

MODEL NUMBER	DIAMETER	HEIGHT	SWIVEL & EYE	BUOYANCY	PACK	SHIPPING WEIGHT
420*	10"	16"	3/8"	25 lbs.	6	14 lbs.
421*	12"	12"	1/2"	30 lbs.	6	30 lbs.
422*	12"	24"	1/2"	62 lbs.	6	42 lbs.
423*	12"	36"	1/2"	126 lbs.	3	38 lbs.
424*	22"	44"	5/8"	414 lbs.	1	18 lbs.
424-T	22"	44"	2" Tube	414 lbs.	1	18 lbs.
424-P	22"	44"	5/8"	414 lbs.	1	18 lbs.

*Furnished with eye and swivel combination.



Barrier Floats

Features Include:

- No Eye on top to keep boats from tying up
- Available in 18" and 24" models
- Hot-Dipped galvanized hardware
- Specify bottom eye or swivel
- Available in White, Orange and Yellow



Model 424-P

BARRIER FLOAT SELECTION CHART

MODEL NUMBER	DIAMETER	HARDWARE	BUOYANCY + or - 5lbs.	PACK	SHIPPING WEIGHT
4402-E	18"	1/2" Eye	90 lbs.	1	14 lbs.
4402-S	18"	1/2" Swivel	90 lbs.	1	14 lbs.
4403-E	24"	5/8" Eye	209 lbs.	1	27 lbs.
4403-S	24"	5/8" Swivel	209 lbs.	1	27 lbs.

Miscellaneous Buoys

Dredge Buoy

Features Include:

- Tough high-density polyethylene body
- Rugged galvanized steel ballast with eye
- PVC pipe light holder (JIM-BUOY 9000-X light priced separately) adds visibility

JIM-BUOY®

DREDGE BUOY SPECIFICATIONS

MODEL NUMBER	DIMENSIONS DIA. x HEIGHT	BALLAST	LIGHT HOLDER	PACK	SHIPPING WEIGHT
506	18" x 24"	22"	22"	1	25 lbs.

Fat Buoys

Features Include:

- Sturdy high-density polyethylene body
- Urethane foam filled
- Hot-dipped 1/2" galvanized hardware
- Used when low visibility required

FAT BUOY SPECIFICATIONS

MODEL NUMBER	DIMENSIONS DIA. x HEIGHT	COLOR	PACK	SHIPPING WEIGHT
4408	12" x 23"	WHITE	1	16 lbs.
4409	12" x 23"	GREEN	1	16 lbs.
4410	12" x 23"	RED	1	16 lbs.



Swim Area Marker Buoy

Features Include:

- Solid high-density polystyrene foam body
- Coated with White marine enamel
- Orange vinyl band and "SWIM AREA" label included
- 1/2" galvanized steel eyebolt molded-in
- Rope Hole 3/4" PVC pipe at waterline

SWIM AREA MARKER BUOY SPECIFICATIONS

MODEL NUMBER	DIMENSIONS DIA. x HEIGHT	PACK	SHIPPING WEIGHT
423-O	12" x 36"	3*	38 lbs.

* Single pack available

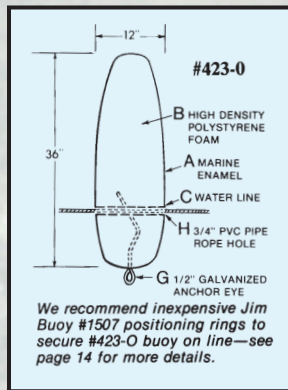

We recommend inexpensive Jim Buoy #1507 positioning rings to secure #423-O buoy on line—see page 14 for more details.



Spar Buoy

Features Include:

- Hard high-density polyethylene shell
- Urethane foam filled
- 1/2" galvanized steel eye
- Low price when many are needed
- Orange vinyl bands included

SPAR BUOY SPECIFICATIONS

MODEL NUMBER	DIMENSIONS DIA. x HEIGHT	PACK	SHIPPING WEIGHT
505	6-1/2" x 31"	1*	6 lbs.

JIM-BUOY®

Sign Rope Buoys

Features Include:

- Marine vinyl coated closed-cell foam
- Heavy galvanized wire
- Available in White or Orange

SIGN ROPE BUOY SPECIFICATIONS

MODEL NUMBER	DIMENSIONS	PACK	SHIPPING WEIGHT
1500	11" x 16" x 1" THICK	12	5 lbs.
1505	7-1/4" DIA. x 3" THICK	12	7 lbs.

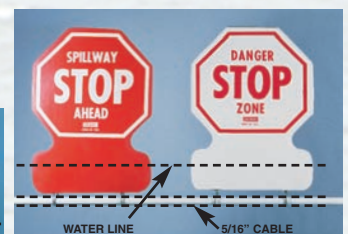
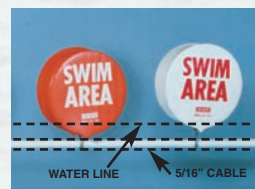

Industrial Rope Floats

Industrial Floats



INDUSTRIAL ROPE FLOAT SELECTION CHART

MODEL NUMBER	SIZE	STD. ROPE-HOLE	BUOYANCY	PACK	SHIPPING WEIGHT	STD. COLOR
4400-RF	12" dia.	1-1/4"*	22 lbs.	4	21 lbs.	WHITE
4401-RF	15" dia.	1-1/4"*	42 lbs.	4	36 lbs.	WHITE
4402-RF	18" dia.	2"*	90 lbs.	1	13 lbs.	WHITE
4403-RF	24" dia.	2"*	209 lbs.	1	28 lbs.	WHITE
4404-RF	30" dia.	2"*	400 lbs.	1	40 lbs.	WHITE
429-RF	18 dia. x30"	2"*	240 lbs.	1	30 lbs.	ORANGE
4418-RF	12 dia. x18"	1-1/4"*	Approx. 60 lbs.	1	10 lbs.	ORANGE

* Call for other rope hole sizes

Features Include:

Hard shell high-density polyethylene construction, urethane foam filled
All models available in White, Orange and Yellow, specify color

Rope Floats

Hard Shell Rope Floats

HARD SHELL ROPE FLOAT SELECTION CHART

MODEL NUMBER	LENGTH	DIAMETER	BUOYANCY	ROPE SIZE	SHIPPING WEIGHT	PER PACK
1100-Y	9-1/4"	7"	10-11 lbs.	1-3/8"	44 lbs.	21
1100-O	9-1/4"	7"	10-11 lbs.	1-3/8"	44 lbs.	21

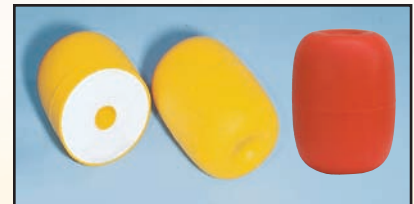

Features Include:

Hard shell high-density polyethylene construction, urethane foam filled
Available in Yellow and Orange, specify Y or O

JIM-BUOY®

Economy Rope Floats

Features Include:

Polystyrene Float
2 Color high visibility



#1504

ECONOMY ROPE FLOAT SELECTION CHART

MODEL NUMBER	LENGTH	DIAMETER	BUOYANCY	ROPE SIZE	SHIPPING WEIGHT	PER PACK	COLOR
1504	5"	3"	2 lbs.	1/2"	3 lbs.	24	RED & WHITE
1506	8"	7"	7-1/2-8 lbs.	1-1/2"	14 lbs.	27	WHITE



#1506

JIM-BUOY®

Rope Floats

Lok-On Rope Floats



Features Include:

Tough outer shell with solid foam filled core
See below for rope-loks to prevent slippage on ropes
Choice of colors

LOK-ON ROPE FLOAT SPECIFICATIONS:

Model No.	Size	Rope Size	Pack	Ship. wt.
1501	3" dia. x 5" lgth.	3/8"-1/2"	24	7 lbs.
1502	5" dia. x 9" lgth.	5/8", 3/4", 7/8"	24	16 lbs.
1503	8" dia. x 14" lgth.	5/8", 3/4", 7/8"	12	33 lbs.

MULTIPLE COLORS AVAILABLE IN ALL FLOAT SIZES—When ordering please indicate choice of colors desired.

B—Blue & White with Red Center Band.
Y—Yellow & White with Red Center Band.
R—Red & White with Blue Center Band.

Rope-Loks & Accessories

Features Include:

Rugged polycarbonate plastic to "bite" into rope
1501, 1502 floats 1 per unit recommended
1503 floats 2 per unit recommended
Cannot be used with cable



ROPE LOKS

MODEL NUMBER	ROPE SIZE	SHIPPING WEIGHT	PER PACK
1501-RL	3/8" to 1/2" Dia.	1 lbs.	24
1502-RL	3/8" to 7/8" Dia.	1 lbs.	24
1503-RL	5/8" to 7/8" Dia.	1 lbs.	24

3/8" Rope Available



Features Include:

Heavy-duty tamper proof design
Stainless steel construction
Fits 5/8", 3/4" and 7/8" diameter rope
Cannot be used with cable

ROPE TERMINALS

MODEL NUMBER	ROPE SIZE.	SHIPPING WEIGHT	PER PACK
1510	5/8" to 7/8" DIA.	4 lbs.	12 pair

Heavy Duty Industrial Floats & Buoys

Industrial Floats & Buoys



Features Include:

- #4418 Rugged high-density polyethylene construction
- Filled with 2lb. density polyurethane flotation foam
- Available with hot-dipped galvanized steel hardware or PVC pipe through holes, specify size
- Rectangular in shape to permit conversion to split-hose floats, see below
- Available in Orange or White

INDUSTRIAL FLOAT & BUOY SELECTION CHART

MODEL NUMBER	SIZE	ROPE HOLE	BUOYANCY	PACK	SHIPPING WEIGHT
4418	12" x 18"	Specify	60 lbs.	1	10 lbs.
429	18" x 30"	Specify	240 lbs.	1	30 lbs.
449	24" x 36"	Specify	300 lbs.	1	42 lbs.
445	24" x 45"	Specify	380 lbs.	1	60 lbs.
548	30" x 48"	Specify	750 lbs.	1	92 lbs.

Jumbo Hose Floats



*All of the above buoys are acceptable as Hose Floats—
Cut in two to allow attachment without end entry.
They may be fitted to any size hose.*

Giant Marine Fenders

Giant Marine Fenders

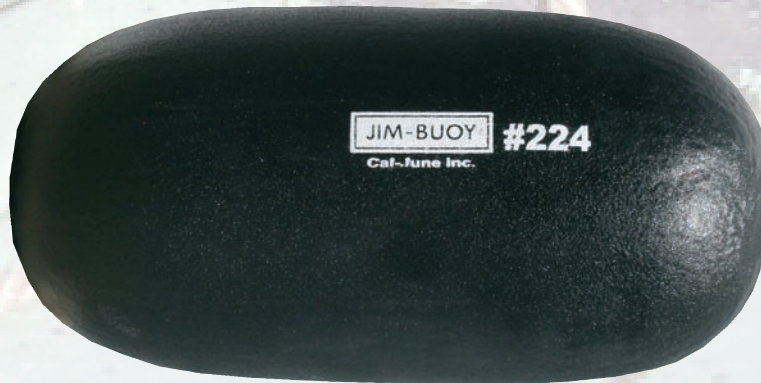
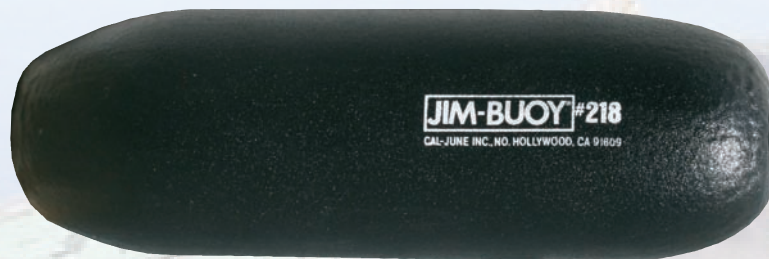
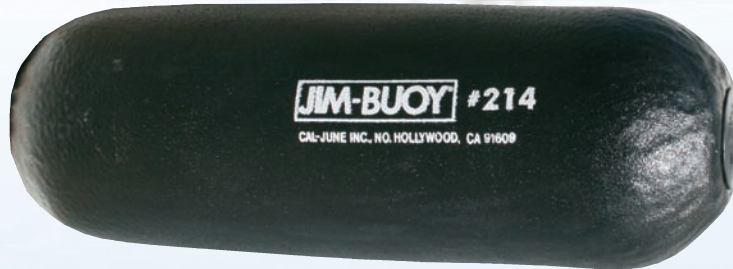

GIANT MARINE FENDERS SELECTION CHART

MODEL NUMBER	DIA.	LENGTH	THRU-HOLE SIZE AND MATERIAL	STAND-OFF DISTANCE	COLORS AVAILABLE	SHIP WEIGHT
212*	12"	34"	1-1/4" PVC	6"	BLACK	40 lbs.
214*	14"	44"	1-1/4" PVC	8"	BLACK	45 lbs.
218*	18"	50"	1-1/4" PVC	12"	BLACK	50 lbs.
224*	24"	53"	1-1/4" PVC	14"	BLACK	70 lbs.

* Available with two galvanized swivels

Dock Bumpers, Corner Bumpers & Roller Bumpers

Roller Bumpers

ROLLER BUMPER SPECIFICATIONS

MODEL NUMBER	DESCRIPTION	DIMENSIONS DIA. x HEIGHT	PACK PER CASE	WEIGHT
5000-C	CORNER MOUNT	12" x 6"	1	16 lbs.
5000-S	STRAIGHT MOUNT	12" x 6"	1	16 lbs.
5006-C	CORNER MOUNT	6" x 3"	6	14 lbs.
5006-S	STRAIGHT MOUNT	6" x 3"	6	12 lbs.
5016-C	CORNER MOUNT	16" x 6"	1	22 lbs.
5016-S	STRAIGHT MOUNT	16" x 6"	1	22 lbs.

Features Include:

- Heavy duty white vinyl bumpers
- Hot dipped galvanized base
- Galvanized steel hardware
- Larger sizes feature 2" diameter axle housing

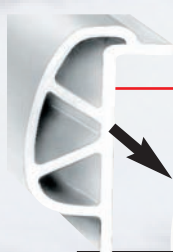

New #5008 corner bumper matches design of new #5013 dock bumper.



Corner Bumpers

CORNER BUMPER SPECIFICATIONS

MODEL NUMBER	DIMENSIONS L x L x H	PACK PER CASE	WEIGHT	USE WITH DOCK BUMPERS
5007	8" x 8" x 4"	12	16 lbs.	5010
5008	10" x 10" x 6"	6	14 lbs.	5013

Features Include:

- Extra volume of cushion at point of contact
- Heavy-duty white vinyl

Dock Bumpers

DOCK BUMPER SPECIFICATIONS

MODEL NUMBER	DIMENSIONS H x D x L	PACK PER CASE	WEIGHT	USE WITH CORNER BUMPERS
5010	3-1/2" x 6" x 6'	10 LENGTHS	42 lbs.	5007
5011	2" x 6" x 6'	10 LENGTHS	40 lbs.	
5012	7-1/2" x 10'	1 LENGTH	55 lbs.	
5013	5-1/2" x 2-1/2" x 6'	3 LENGTHS	44 lbs.	5008

Features Include:

- Heavy-duty white vinyl
- 5012 designed for heavy commercial use and large vessels

JIM-BUOY®



Boom Buoys

Model #1710- Please call for quotation for your particular application

KEEPS BOATS OUT!

Sea Anchors

Trolling Sea Anchors



Model #929

Features Include:

- Vinyl-coated nylon construction
- 1" polypropylene shroud lines
- Easily collapsed for storage
- Storage pouch included

JIM-BUOY®

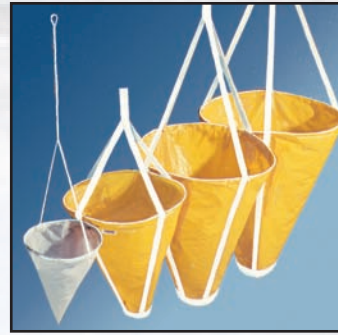

Model #929X

SEA ANCHOR SPECIFICATIONS

MODEL NUMBER	USE	DIAMETER	PACK	SHIPPING WEIGHT
925	HORSESHOE BUOY	10"	12	4 lbs.
926	TROLLING	18"	6	5 lbs.
927	TROLLING	24"	6	6 lbs.
928	TROLLING	30"	6	8 lbs.
929*	STORM	36"	2	16 lbs.

* U.S.C.G. approval # 160.019/15/0

Coasters and Key Chains

JIM-BUOY®
NO-TIP DRINK Coasters
Realistic life ring styling in miniature

Resilient foam fits most cocktail glasses, soft drink cans, etc.—Ideal non-spill drink holder aboard boat or anywhere as a distinctive coaster. Features multi-colored bands on white buoy joined with realistic white grab line and actual Jim Buoy label.
Display packaged

Model #400 6 different colored rings per displayed package with full color header. 12 display packages per case, shipping weight 6lbs.

JIM-BUOY® Floating Key Chain

Individually skin-packed for display

FLOATING Key Chain
Floats up to 3 keys!

Match the style and color to your real "Jim Buoy" aboardship! Complete in detail with white grab lines (ring buoy only) and actual Jim Buoy label on all models. Features vinyl coated 1/2" foam buoy with corrosion resistant chain.

All models skin-packed on a beautiful display card with bar code for rack sales. 12 per box, ship. wt. 1 lb.

Model #85—Yellow horseshoe buoy
Model #86—White horseshoe buoy

Model #87—White life ring.
Model #88—Orange life ring.

Personalized Key Chains—Please call for price and delivery on custom logo/name imprints in bulk quantities.

Four Great Models



Life Guard Equipment

Rescue Tubes



Model #79

Model #79 Features Include:

- Soft, flexible resilient vinyl coated foam
- Adjustable 2" wide shoulder strap

Model #80 Features Include:

- Nylon security line and one-piece body belt
- All hardware stainless steel



Model #80

RESCUE TUBE SPECIFICATIONS



MODEL NUMBER	DIMENSIONS	COLOR	PACK PER CASE	WEIGHT PER CASE
79*	49"x 6"x 4"	Orange*	6	12 lbs.
80*	36"x 6"x 3"	Orange	6	16 lbs.

*Other colors, special labeling available ie. Jr. Lifeguard - Contact Factory

Rescue Cans

RESCUE CAN SPECIFICATIONS

MODEL NUMBER	DIMENSIONS	COLOR	PACK PER CASE	WEIGHT PER CASE
81	27 1/2"x 9 1/2"	Orange	1	4 lbs.
82*	27 1/2"x 9 1/2"	Orange	1	4 lbs.

*With pocket mask cavity

Features Include:

- Six hand grips
- Bright day-glo orange



Model #82

Rescue Can Rack

Features Include:

- Stainless steel with pre-drilled mounting holes
- Fits #81 & #82

RESCUE CAN RACK SPECIFICATIONS

MODEL NUMBER	DIMENSIONS	PACK PER CARTON
83	8 1/2"x 5 1/4"	1

If ordering #81 or #82 rack is packed on rescue can

Softee Spine Board

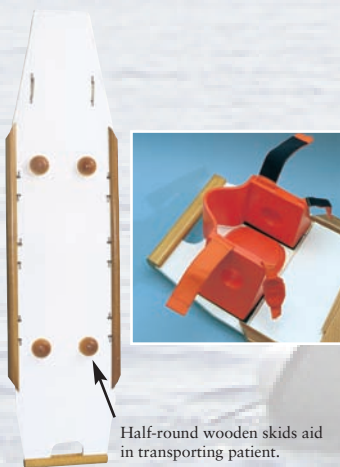

Half-round wooden skids aid in transporting patient.

Features Include:

- Soft, resilient surface
- Head security-pad below and on sides of head for maximum support
- 2 1/2" Nylon body and leg straps
- Shipped with straps fully installed



SOFTEE SPINE BOARD SPECIFICATIONS

MODEL NUMBER	DIMENSIONS	SHIPPING WEIGHT	PACK PER CARTON
84	18"x 71"	25 lbs.	1

Pool Chairs and Lounge Pads

Santa Barbara Fun Chair

JIM-BUOY®

Features Include:

- Vinyl coated, Closed-cell foam provides comfort
- Internal aluminum frame provides strength and durability
- Plush, restful head cushion
- Drink holders in both arms
- Available with footrest extension, add "X" to model #

SANTA BARBARA FUN CHAIR SPECIFICATIONS

MODEL NUMBER	COLOR	DIMENSIONS W x L x H	PACK PER CASE	WEIGHT PER CASE
7001	SPECIFY	31"x 42"x 26"	1	16 lbs.
7001-X	SPECIFY	31"x 65"x 26"	1	16 lbs.



Available with Footrest extension. Available in white, blue, turquoise and yellow. Please specify color when ordering. Model #7001X (Not sold separately)

Fun Chair

JIM-BUOY®

Features Include:

- Same aluminum frame, vinyl coated foam construction as the Santa Barbara Fun Chair
- Somewhat smaller design
- Same comfort and strength
- Available in White, Blue, Yellow and Turquoise



FUN CHAIR SPECIFICATIONS

MODEL NUMBER	COLOR	DIMENSIONS W x L x H	PACK PER CASE	WEIGHT PER CASE
7000	SPECIFY	28"x 40"x 23"	1	15 lbs.

Executive Lounge Pad

JIM-BUOY®

Features Include:

- Solid foam core completely covered with tough marine vinyl coating
- Features 11"x 27"x 7" permanently sealed air pillow for additional comfort
- Available in White, Blue, Yellow and Turquoise
- Ships U.P.S.

EXECUTIVE LOUNGE PAD SPECIFICATIONS

MODEL NUMBER	COLOR	DIMENSIONS W x L x H	PACK PER CASE	WEIGHT PER CASE
7004	SPECIFY	27"x 72"x 1-1/4"	1	12 lbs.



Index

	Page
Anchor Marker.....	16
Anchoring System.....	16
Barrier Floats & Systems.....	18,24
Boom Buoys.....	24
Bumpers—dock, corner, roller.....	24
Buoy Protectors.....	17
Buoyant Apparatus, U.S.C.G.Approved.....	9
Cabinet, Life Ring.....	4
Channel Markers.....	12,13,14
Coasters, Drink.....	25
Cushion, Boat.....	7
Daymarks, Regulatory Buoy.....	12
Daymark Signals.....	8
Distress SOS Flag.....	7
Dock Bumpers.....	24
Bumpers.....	24
Corners.....	24
Rollers.....	24
Dredge Buoys.....	19
Executive Lounge Pad.....	27
Fast Water Buoy.....	13
Fat Buoy.....	19
Fenders.....	23
Flag, SOS Distress.....	7
Float-Free Link, Painter & Cage.....	9
Floats—	
Industrial.....	20, 22
Rope.....	20
Fun Chairs.....	27
Hangers For Ring Buoys.....	6
Hardware—Stainless & Galvanized.....	21
Horseshoe Buoys & Racks.....	10
Hose Floats.....	22
Key Chains.....	25
Lettering Kit.....	2, 10
Life Guard Equipment—	
Rescue Cans.....	26
Rescue Can Racks.....	26
Rescue Tubes.....	26
Spine Board.....	26
Life Preservers & Placards.....	7
Life Floats, U.S.C.G. Approved.....	9
Life Rings.....	2, 3
Canadian Approved.....	4
Canvas.....	5
Economy.....	5
MED Approved.....	2
Plastic.....	5
SOLAS.....	2
U.S.C.G. Approved.....	2, 3
Lights—	
Jacket.....	8
Regulatory Buoy.....	15
Solar Powered.....	15
Utility.....	15
U.S.C.G. Appv. Man Overboard Light.....	8
Lounge Pad.....	27
Man Overboard Lights, U.S.C.G. Appv.....	8
Marine Fenders.....	23
Mast Buoys.....	11
Mooring Buoys.....	16, 17, 18, 19
Mooring Anchors.....	15
Moor-Pro Buoy Protectors.....	17
Oil Cans.....	25
Pendant Mooring Buoys.....	17
PFD Lights.....	8
Pick-Up Buoys.....	11
Poles, Man Overboard & Mounts.....	11
Pool Chairs.....	27
Positioning Rings.....	20
Racks—	
Horseshoe Buoy.....	10
Life Ring.....	6
Regulatory Buoys.....	12, 13, 14, 19
Regulatory Buoy Labels.....	15
Rescue Can & Tube.....	26
River Buoys.....	12
Rope Floats & Loks.....	20, 21
Safety Station.....	4
Sea Anchors.....	25
Sign Rope Buoys.....	19
Sombrero Buoys.....	14
Spar Buoys.....	17,19
Spine Boards.....	26
Star Plate Assembly.....	17
Tide Master.....	15
Trip-Line and Anchor Marker.....	11
Winter Spar Buoy.....	17

JIM-BUOY®

A DIVISION OF

CAL-JUNE

INCORPORATED

POST OFFICE BOX 9551

NORTH HOLLYWOOD, CA 91609-1551

(818) 761-3516 • FAX (818) 761-3165

email@jimbuoy.com • www.jimbuoy.com