

Material : Mild steel
 Safety factor : ≤ 85 ton 6 times
 > 85 ton 5 times
 Finish : Painted
 Temperature range : -20°C up to +200°C
 Standard certification : Certificate of Conformity

Suitable for HMPE rope and wire rope
 Non-standard sizes or custom products available on request

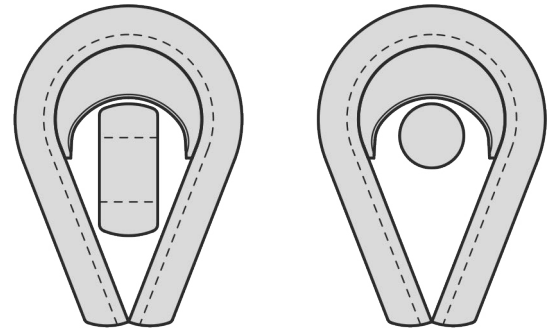

Designed to fit shackle bow and shackle pin

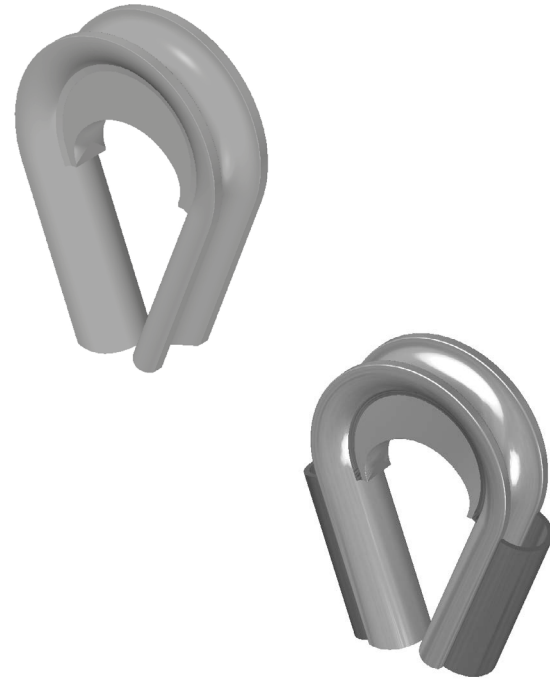

Also available with retaining bands on request

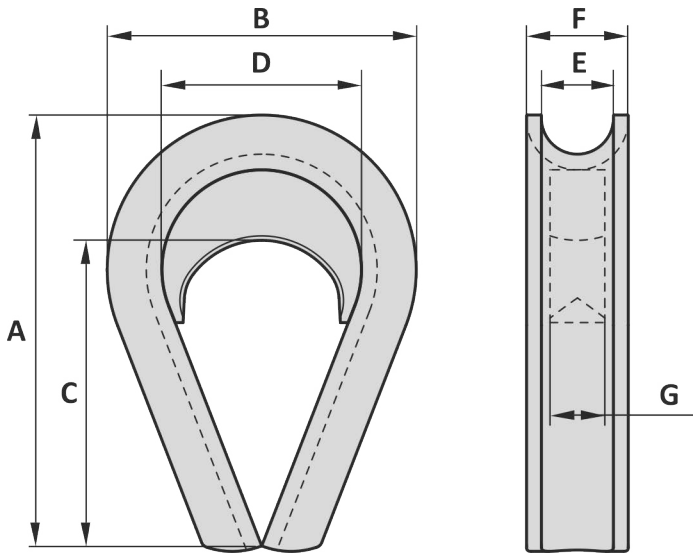

Art. No.	WLL ton	PL kN	MBL ton	Rope mm	A inch	B mm	C mm	D mm	E mm	F mm	G mm	Weight kg
11108888	25	491	150	35 - 38	10	190	180	120	41	52	30	5.5
11118888	35	687	210	39 - 42	11	210	190	130	46	60	40	9.1
11128888	42.5	834	255	44 - 48	12	245	210	145	52	65	40	9.2
11148888	55	1080	330	52 - 56	14	260	245	155	60	72	40	11
11178888	85	1668	510	60 - 64	17	310	320	190	70	84	50	23
11198888	120	2356	600	68 - 76	19	350	350	230	81	119	60	37
11228888	150	2944	750	80 - 89	22	395	390	255	92	130	70	50
11248888	200	3924	1000	92 - 102	24	430	440	280	105	145	80	65
11268888	250	4906	1250	104 - 114	26	450	470	285	120	155	90	76

Tolerance: Forged parts ± 5%

Art. No.	WLL ton	PL kN	MBL ton	Rope mm	A inch	B inch	C inch	D inch	E inch	F inch	G inch	Weight lbs
11108888	25	491	150	35 - 38	10	7 1/2	7 3/2	4 2/2	1 5/8	2 1/16	1 3/16	12
11118888	35	687	210	39 - 42	11	8 1/4	7 15/2	5 1/8	1 13/16	2 3/8	1 1/16	20
11128888	42.5	834	255	44 - 48	12	9 2/2	8 1/4	5 23/2	2 1/16	2 9/16	1 1/16	20
11148888	55	1080	330	52 - 56	14	10 1/4	9 21/2	6 3/2	2 3/8	2 27/2	1 1/16	24
11178888	85	1668	510	60 - 64	17	12 3/16	12 19/2	7 15/2	2 3/4	3 5/16	1 31/2	51
11198888	120	2356	600	68 - 76	19	13 25/2	13 25/2	9 1/16	3 3/16	4 11/16	2 3/8	82
11228888	150	2944	750	80 - 89	22	15 9/16	15 11/2	10 1/2	3 5/8	5 1/8	2 3/4	110
11248888	200	3924	1000	92 - 102	24	16 15/16	17 5/16	11 1/2	4 1/8	5 23/2	3 5/2	143
11268888	250	4906	1250	104 - 114	26	17 23/2	18 1/2	11 1/2	4 23/2	6 3/2	3 9/16	168

Tolerance: Forged parts ± 5%

10-02-2016